

Calibration book

Cucumis sativus L.

Cucumber

Naktuinbouw calibration book

Cucumis sativus

cucumber & gherkin

Version 1

© Naktuinbouw, December 2010

© Naktuinbouw 2010

No part of this electronic/digital edition may be reproduced in any form, by print, photoprint, microfilm or any other means without written permission from Naktuinbouw.

Introduction

In front of you, you find the Naktuinbouw calibration book for cucumber. This book may be used as guidance for the completion of application forms, the describing of varieties or the understanding of variety descriptions. This book can not replace the skill needed to make a variety description, but may serve as support.

Sources used

The basis for this book is the CPVO protocol CPVO-TP/061/2 which in turn is based on UPOV Guideline TG/61/7. Please also use these sources for reference when using this calibration book.

The application of this calibration book is based on the general UPOV principles on the definitions and use of characteristics of variety descriptions (UPOV TG/1/3)

Application methodology

The UPOV system is based on the expression of characteristics that are related to the expression values of example varieties. In the calibration book you find two types of characteristics; visually assessed characteristics and measured characteristics.

The value of the visually assessed characteristics can be compared with the visual value of the expression of example varieties. In the calibration book you may find drawings or pictures to assist in the decision on the applicable expression. For measured characteristics this is more complicated as in many cases the value of the measurements is depending on the (climatical) conditions of the trials. The use of example varieties in these cases is indispensable. The same applies for those visually assessed characteristics that are prone to influence by climate (e.g. anthocyanin coloration). In this calibration book these example varieties are only included for the characteristics that appear in the Technical Questionnaire. Others are not included as many prefer their own set of example varieties, but may be found in the relevant CPVO protocol.

Website

The CPVO and UPOV documents mentioned above can be found on the Naktuinbouw website (<http://www.naktuinbouw.nl/onderwerp/kalibratieboeken>). On this website you can also find announcements of possible modifications of the published calibration books.

Helpdesk

For possible remarks, suggestions and questions on the calibration books and the website, you may contact Naktuinbouw at our email address: kalibratieboek@naktuinbouw.nl

Contents

Nr.	Part	Characteristic
1	Cotyledon	bitterness
2	Plant	growth type
3	Plant	total length of first 15 internodes
4	Leaf blade	attitude
5	Leaf blade	length
6	Leaf blade	ratio length of terminal lobe/length of blade
7	Leaf blade	shape of apex of terminal lobe
8	Leaf blade	intensity of green colour
9	Leaf blade	blistering
10	Leaf blade	undulation of margin
11	Leaf blade	dentation of margin
12	Flowers	time of development of female flowers (80% of plants with at least one female flower)
13	Plant	sex expression
14	Plant	number of female flowers per node
15	Ovary	colour of vestiture
16	Parthenocarpy	
17	Fruit	length
18	Fruit	diameter
19	Fruit	ratio length/diameter
20	Fruit	core diameter in relation to diameter of fruit
21	Fruit	shape in transverse section
22	Fruit	shape of stem end
23	Fruit	only necked varieties: Fruit: length of neck
24	Fruit	shape of calyx end
25	Fruit	ground colour of skin at market stage
26	Fruit	excluding white varieties: Fruit: intensity Of ground colour of skin
27	Fruit	ribs
28	Fruit	sutures
29	Fruit	creasing
30	Fruit	degree of creasing
31	Fruit	type of vestiture
32	Fruit	density of vestiture
33	Fruit	only varieties with white ovary vestiture: Fruit: colour of vestiture
34	Fruit	warts
35	Fruit	size of warts
36	Fruit	length of stripes
37	Fruit	dots
38	Fruit	distribution of dots
39	Fruit	length of fruit containing dots
40	Fruit	density of dots
41	Fruit	glaucosity

42	Fruit	length of peduncle
43	Fruit	ground colour of skin at physiological ripeness
44		resistance to <i>Cladosporium cucumerinum</i> (Ccu)
45		resistance to Cucumber Mosaic Virus (CMV)
46		resistance to powdery mildew (<i>Pododospaera xanthii</i>) (Px)
47		resistance to downy mildew (<i>Pseudoperonospora cubensis</i>) (Pc)
48		resistance to Corynespora blight and target leaf spot (<i>Corynespora cassicola</i>) (Cca)
49		resistance to Cucumber Vein Yellowing Virus (CVYV)
50		resistance to Zucchini Yellow Mosaic Virus (ZYMV)

1 Cotyledon: bitterness

Grouping characteristic: yes.

Type of characteristic: QL – Qualitative characteristic.

Type of observation: VG – Single visual assessment of a group of plants or parts of plants; in practice a single assessment of an average single plant or part of plant.

Stage of observation: On seedlings just before the development of the first true leaf.

Method of observation: Take a piece of the cotyledon and taste whether it is bitter. This is best tried on the back part of the tongue where the taste buds are sensitive to bitterness. Assess 2-3 plants per sample. If determined as bitter, rinse mouth with water.

Notes, states of expression and example varieties:

1: absent Rocket GS, Sandra
9: present Farbio



2 Plant: growth type

Grouping characteristic: no.

Type of characteristic: QL – Qualitative characteristic.

Type of observation: VG – Single visual assessment of a group of plants or parts of plants; in practice a single assessment of an average single plant or part of plant.

Stage of observation: Perform observations on adult plants only.

Method of observation: Visual observation. A determinate plant has a short vine, with short internodes and with the stem terminating in flowers. Calibrate using example varieties and explanatory photo.

Notes and states of expression:

- 1: determinate
- 2: indeterminate

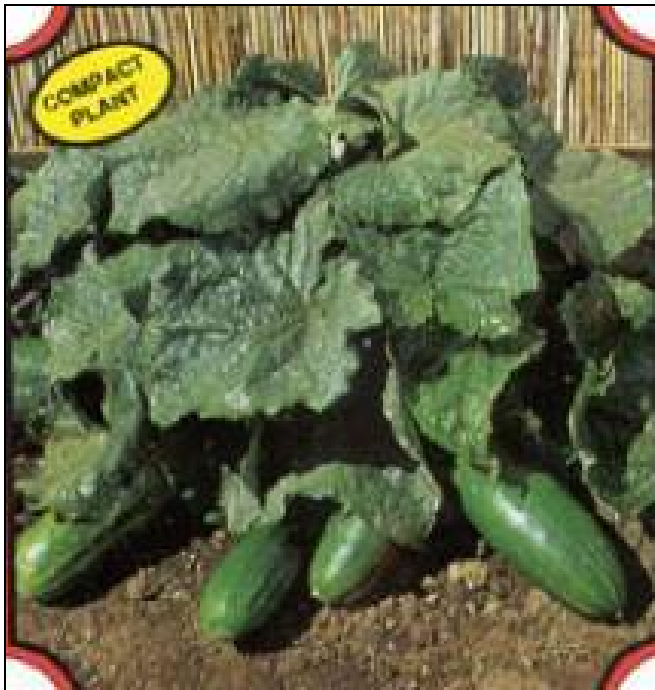

1: determinate (source: www.earlmay.com)

3 Plant: total length of first 15 internodes

Grouping characteristic: no.

Type of characteristic: QN – Quantitative characteristic.

Type of observation: MS/MG: -Choice between

- Calculated average of the measurement of 20 plants or parts of plants and
- Single measurement of a group of plants or parts of plants; in practice a single measurement of an average single plant or part of plant

Stage of observation: When the relevant part of the main stem is fully developed. Perform observations when the varieties have developed at least 20 nodes or when the first 15 internodes have obtained their full length.

Method of observation: Measurements of a number of individual plants or a group of plants or parts of plants. There are two methods:

- a. Count the number of nodes from the cotyledons to a certain length. In the glasshouse this is usually the horizontal wire at 2,5 m or higher to which the vertically growing plant is attached. Calculate the average number of nodes per application.
- b. Count the first 15 internodes and measure the length of those altogether. This method is more appropriate for varieties growing in the field without support.

Calibrate using example varieties.

Notes and states of expression:

- 1: very short
- 2: very short to short
- 3: short
- 4: short to medium
- 5: medium
- 6: medium to long
- 7: long
- 8: long to very long
- 9: very long

4 Leaf blade: attitude

Grouping characteristic: no.

Type of characteristic: **QN** – Quantitative characteristic.

Type of observation: **VG** – Single visual assessment of a group of plants or parts of plants; in practice a single assessment of an average single plant or part of plant.

Stage of observation: On fully developed leaves (after the 15th node has appeared).

Method of observation: Visual observation. To be observed only for staked, vertically grown varieties
Calibrate using example varieties and explanatory drawings.

Notes and states of expression:

- 1: erect
- 2: horizontal
- 3: drooping

CPVO explanation:

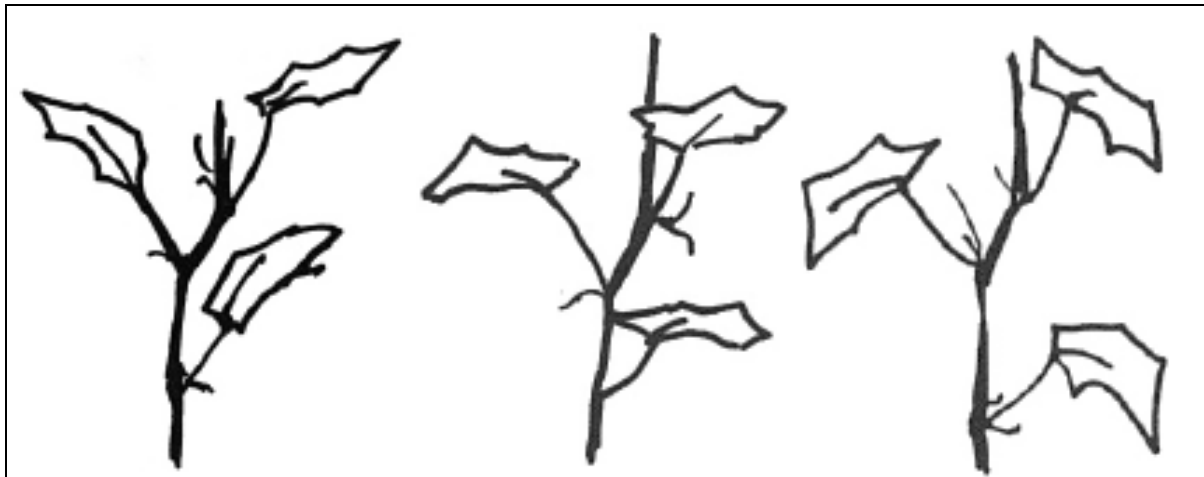

1: erect

2: horizontal

3: drooping

5 Leaf blade: length

Grouping characteristic: no.

Type of characteristic: QN – Quantitative characteristic.

Type of observation: MS/VG – Choice between

- Calculated average of the measurement of 20 plants or parts of plants and
- Single visual assessment of a group of plants or parts of plants; in practice a single assessment of an average single plant or part of plant

Stage of observation: On fully developed leaves (after the 15th node has appeared).

Method of observation: Visual observation. Calibrate using example varieties and explanatory drawing.

Notes and states of expression:

- 1: very short
- 2: very short to short
- 3: short
- 4: short to medium
- 5: medium
- 6: medium to long
- 7: long
- 8: long to very long
- 9: very long

CPVO explanation:

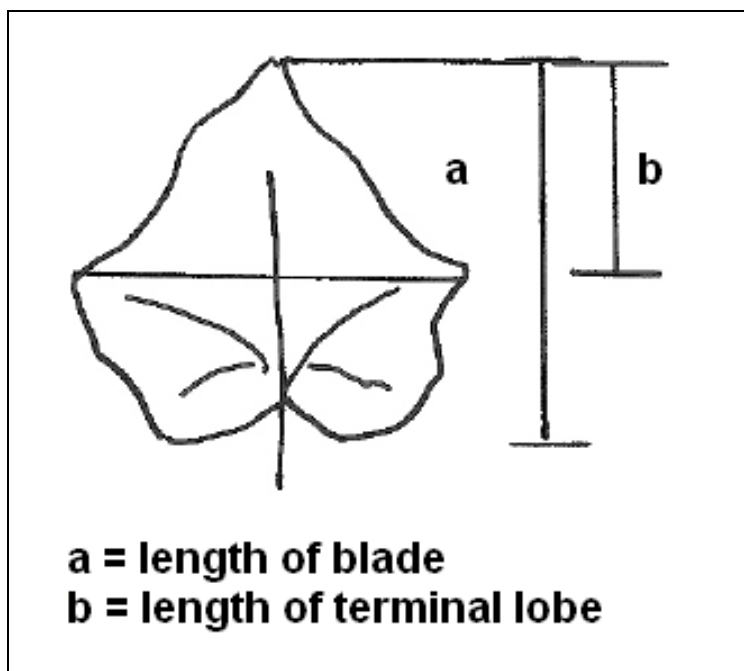

6 Leaf blade: ratio length of terminal lobe/length of blade

Grouping characteristic: no.

Type of characteristic: QN – Quantitative characteristic.

Type of observation: MS/VG – Choice between

- Calculated average of the measurement of 20 plants or parts of plants and
- Single visual assessment of a group of plants or parts of plants; in practice a single assessment of an average single plant or part of plant

Stage of observation: On fully developed leaves (after the 15th node has appeared).

Method of observation: Visual observation. Calibrate using example varieties and explanatory drawing.

Notes and states of expression:

- 1: very small
- 2: very small to small
- 3: small
- 4: small to medium
- 5: medium
- 6: medium to large
- 7: large
- 8: large to very large
- 9: very large

CPVO explanation:

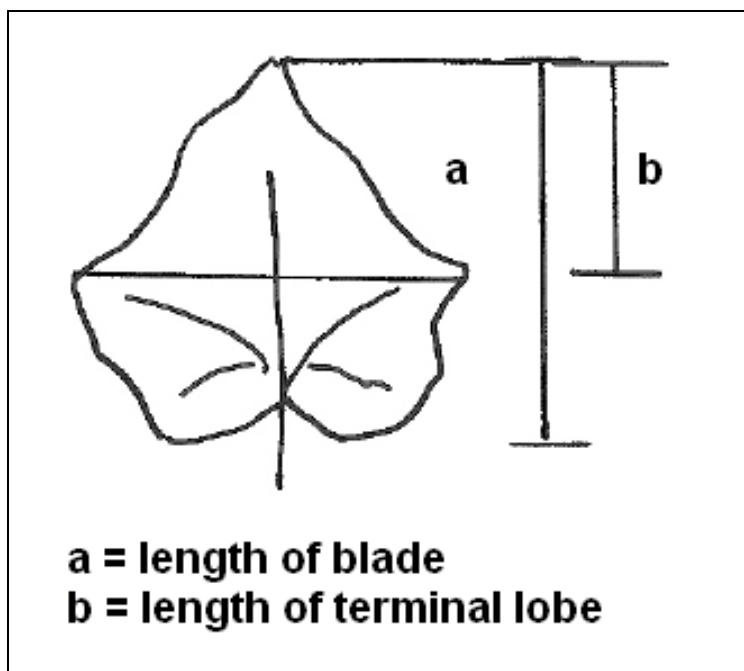

7 Leaf blade: shape of apex of terminal lobe

Grouping characteristic: no.

Type of characteristic: PQ – Pseudo-qualitative characteristic.

Type of observation: VG – Single visual assessment of a group of plants or parts of plants; in practice a single assessment of an average single plant or part of plant.

Stage of observation: On fully developed leaves (after the 15th node has appeared).

Method of observation: Visual observation. Calibrate using example varieties and explanatory drawing.

Notes and states of expression:

- 1: acute
- 2: right-angled
- 3: obtuse
- 4: rounded

CPVO explanation:

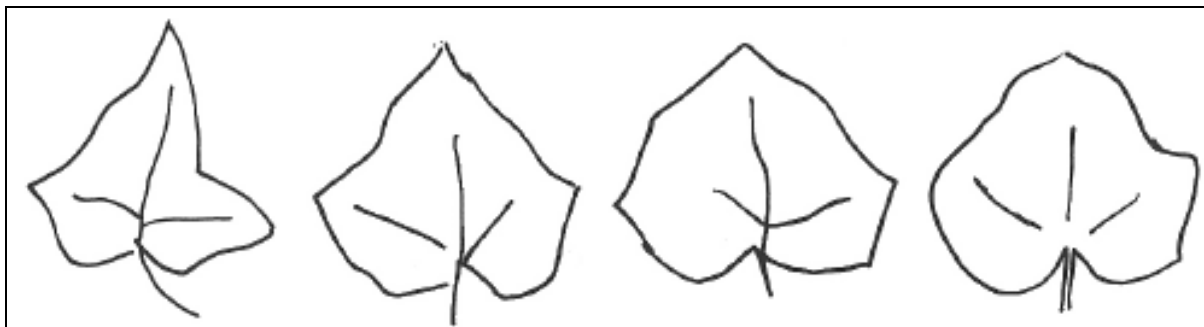

1: acute

2: right-angled

3: obtuse

4: rounded

8 Leaf blade: intensity of green colour

Grouping characteristic: no.

Type of characteristic: **QN** – Quantitative characteristic.

Type of observation: **VG** – Single visual assessment of a group of plants or parts of plants; in practice a single assessment of an average single plant or part of plant.

Stage of observation: On fully developed leaves (after the 15th node has appeared).

Method of observation: Visual observation. Calibrate using example varieties.

Notes and states of expression:

- 1: very light
- 2: very light to light
- 3: light
- 4: light to medium
- 5: medium
- 6: medium to dark
- 7: dark
- 8: dark to very dark
- 9: very dark



3: light

5: medium

7: dark

These images serve only to illustrate some of the variation in expression present in the crop and should not be used as an absolute reference.

9 Leaf blade: blistering

Grouping characteristic: no.

Type of characteristic: QN – Quantitative characteristic.

Type of observation: VG – Single visual assessment of a group of plants or parts of plants; in practice a single assessment of an average single plant or part of plant.

Stage of observation: Stage of observation: On fully developed leaves (after the 15th node has appeared).

Method of observation: Visual assessment by a single observation of a group of plants or parts of plants. Calibrate using example varieties.

Notes and states of expression:

- 1: absent or very weak
- 2: very weak to weak
- 3: weak
- 4: weak to medium
- 5: medium
- 6: medium to strong
- 7: strong
- 8: strong to very strong
- 9: very strong



3: weak



5: medium



7: strong

10 Leaf blade: undulation of margin

Grouping characteristic: no.

Type of characteristic: **QN** – Quantitative characteristic.

Type of observation: **VG** – Single visual assessment of a group of plants or parts of plants; in practice a single assessment of an average single plant or part of plant.

Stage of observation: **Stage of observation:** On fully developed leaves (after the 15th node has appeared).

Method of observation: Visual observation. Calibrate using example varieties. Note that the margin is to be observed, not the undulation of the leaf blade surface.

Notes and states of expression:

- 1: absent or weak
- 2: moderate
- 3: strong

11 Leaf blade: dentation of margin

Grouping characteristic: no.

Type of characteristic: **QN** – Quantitative characteristic.

Type of observation: **VG** – Single visual assessment of a group of plants or parts of plants; in practice a single assessment of an average single plant or part of plant.

Stage of observation: On fully developed leaves (after the 15th node has appeared).

Method of observation: Visual observation. Calibrate using example varieties.

Notes and states of expression:

- 1: very weak
- 2: very weak to weak
- 3: weak
- 4: weak to medium
- 5: medium
- 6: medium to strong
- 7: strong
- 8: strong to very strong
- 9: very strong

12 Time of development of female flowers (80% of plants with at least one female flower)

Grouping characteristic: no.

Type of characteristic: **QN** – Quantitative characteristic.

Type of observation: **MG** – Single measurement of a group of plants or parts of plants; in practice a single measurement of an average single plant or part of plant.

Stage of observation: Young plants at the time of beginning of development of female flowers.

Method of observation: Observe at regular intervals the beginning of the female flowering, so when the plants show the first female flower. Use the dates to calibrate with example varieties.

Notes and states of expression:

- 1: very early
- 2: very early to early
- 3: early
- 4: early to medium
- 5: medium
- 6: medium to late
- 7: late
- 8: late to very late
- 9: very late

13 Plant: sex expression

Grouping characteristic: no.

Type of characteristic: QL – Qualitative characteristic.

Type of observation: VG – Single visual assessment of a group of plants or parts of plants; in practice a single assessment of an average single plant or part of plant.

Stage of observation: : When all plants of the variety are fully flowering, on flowers between the 5th and 15th nodes.

Method of observation: Visual observation on all of the nodes of the plant. Calibrate using example varieties, explanation and explanatory photo's.

Notes, states of expression and example varieties:

1: monoecious	Hokus
2: subgynoecious	Toska 70
3: gynoecious	Farbio, Sandra, Wilma
4: hermaphroditic	Sunsweet

Explanation:

1: Monoecious: (Male and female flowers) All nodes on the plants have both male and female flowers, with more male than female flowers on each node. Male and female flowers (i.e. mixed flowering) means that in some cases, axils with only male flowers can be encountered.

2: Subgynoecious: (mostly female flowers) Mostly female flowers means that in some cases male flowers can be found.

3: Gynoecious (Usually only female flowers). Usually only female flowers means that in general, male flowers do not appear, unless climatic conditions favour the development of male flowers.

4. Hermaphrodytic (mostly hermaphrodite flowers)

Climatic conditions can influence sex expression. Lower temperatures favour the development of male flowers to such an extent, that a variety which carries only female flowers (3), will appear to have mostly female flowers (2).

13 Plant: sex expression



1. monoecious



3. gynoecious

14 Plant: number of female flowers per node

Grouping characteristic: no.

Type of characteristic: QN – Quantitative characteristic.

Type of observation: VG – Single visual assessment of a group of plants or parts of plants; in practice a single assessment of an average single plant or part of plant.

Stage of observation: When all plants of the variety are fully flowering, on flowers between the 5th and 15th nodes.

Method of observation: Count the number of female flowers per node, Calibrate using example varieties, explanation and explanatory photo's.

CPVO explanation:

Where there are more than 50% of nodes with one flower or two flowers, the state of expression is predominantly one or predominantly two, respectively. In other cases, the state is that which represents the highest percentage.

Notes and states of expression:

- 1: predominantly one
- 2: predominantly one or two
- 3: predominantly two
- 4: predominantly two or three
- 5: predominantly three or four
- 6: predominantly four or five
- 7: predominantly more than five



1: predominantly one



6: predominantly four or five

15 Ovary: colour of vestiture

Grouping characteristic: yes.

Type of characteristic: QL – Qualitative characteristic.

Type of observation: VG – Single visual assessment of a group of plants or parts of plants; in practice a single assessment of an average single plant or part of plant.

Stage of observation: : When all plants of the variety are fully flowering, on flowers between the 5th and 15th nodes, on the ovary during or directly after the female flowering has flowered.

Method of observation: Visual observation. The colour of hairs/prickles can also be observed on the hairs on the outside of the corolla: the tip of these are either white (transparent) or black. Calibrate using example varieties and explanatory photo's.

Notes, states of expression and example varieties:

- 1: white Jazzzer
- 2: black Vert petit de Paris



1: white

2: black

16 Parthenocarpy

Grouping characteristic: no.

Type of characteristic: QL – Qualitative characteristic.

Type of observation: VG – Single visual assessment of a group of plants or parts of plants; in practice a single assessment of an average single plant or part of plant.

Stage of observation: between the 5th and 15th nodes.

Method of observation: In conditions excluding the possibility of insect pollination (bees, bumblebees), i.e. in an insect-free greenhouse.

Parthenocarp as well as non parthenocarp varieties should be included in the trial. Be aware that non parthenocarp usually are monoecious or subgynoecious varieties which produce male flowers. Sometimes they appear to be weakly parthenocarpic. Pollination must be avoided at all times.

Notes, states of expression and example varieties:

1: absent Toska 70
9: present Farbio, Rocket GS, Sandra, Wilma

Explanation:

Parthenocarpy is the formation of fruit without pollination having taken place.

17 Fruit: length

Grouping characteristic: yes.

Type of characteristic: QN – Quantitative characteristic.

Type of observation: MS/VG – Choice between

- Calculated average of the measurement of 20 plants or parts of plants and
- Single visual assessment of a group of plants or parts of plants; in practice a single assessment of an average single plant or part of plant

Stage of observation: on stem fruits around 14 days after the flower has blossomed, between the 5th and 15th node

Method of observation: Visual observation or measurement preferably on harvested stem fruits. Calibrate using example varieties.

Notes, states of expression and example varieties:

- | | |
|------------------------|---------------------|
| 1: very short | De Russie, Sunsweet |
| 2: very short to short | |
| 3: short | |
| 4: short to medium | |
| 5: medium | Gemini, Jazzer |
| 6: medium to long | |
| 7: long | Corona |
| 8: long to very long | |
| 9: very long | |



2: very short to short

3: short

5: medium

7: long

18 Fruit: diameter

Grouping characteristic: no.

Type of characteristic: QN – Quantitative characteristic.

Type of observation: MS/VG – Choice between

- Calculated average of the measurement of 20 plants or parts of plants and
- Single visual assessment of a group of plants or parts of plants; in practice a single assessment of an average single plant or part of plant

Stage of observation: on stem fruits around 14 days after the flower has blossomed, between the 5th and 15th node

Method of observation: Visual observation or measurement preferably on harvested stem fruits. Calibrate using example varieties.

Notes and states of expression:

- 1: very small
- 2: very small to small
- 3: small
- 4: small to medium
- 5: medium
- 6: medium to large
- 7: large
- 8: large to very large
- 9: very large

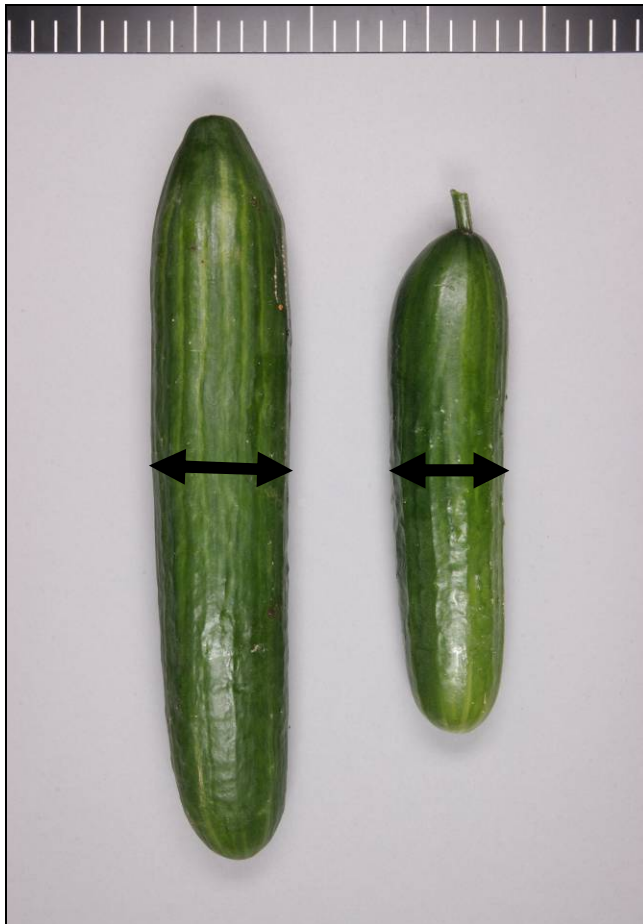

19 Fruit: ratio length/diameter

Grouping characteristic: no.

Type of characteristic: **QN** – Quantitative characteristic.

Type of observation: **MS/VG** – Choice between

- Calculated average of the measurement of 20 plants or parts of plants and
- Single visual assessment of a group of plants or parts of plants; in practice a single assessment of an average single plant or part of plant

Stage of observation: on stem fruits around 14 days after the flower has blossomed, between the 5th and 15th node

Method of observation: Visual observation or measurement preferably on harvested stem fruits. Calibrate using example varieties.

Notes and states of expression:

- 1: very small
- 2: very small to small
- 3: small
- 4: small to medium
- 5: medium
- 6: medium to large
- 7: large
- 8: large to very large
- 9: very large

19 Fruit: ratio length/diameter

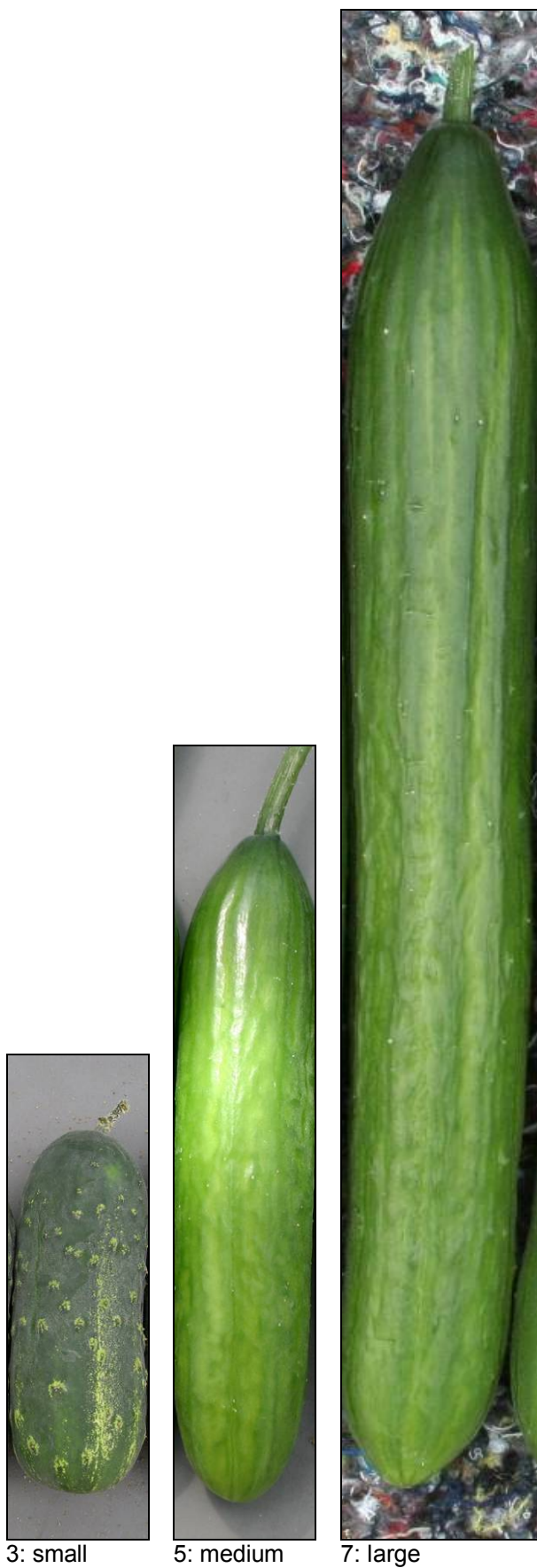

20 Fruit: core diameter in relation to diameter of fruit

Grouping characteristic: yes.

Type of characteristic: QN – Quantitative characteristic.

Type of observation: VG – Single visual assessment of a group of plants or parts of plants; in practice a single assessment of an average single plant or part of plant

Stage of observation: on stem fruits around 14 days after the flower has blossomed, between the 5th and 15th node

Method of observation: Visual observation. Evaluate character by cutting several fruits in half. The value 5 (medium) is awarded when the distance of the center of the fruit to the exterior of the seed cavity is equal to the distance of the exterior of the seed cavity to the exterior of the fruit.

Notes and states of expression:

- 1: very small
- 2: very small to small
- 3: small
- 4: small to medium
- 5: medium
- 6: medium to large
- 7: large
- 8: large to very large
- 9: very large

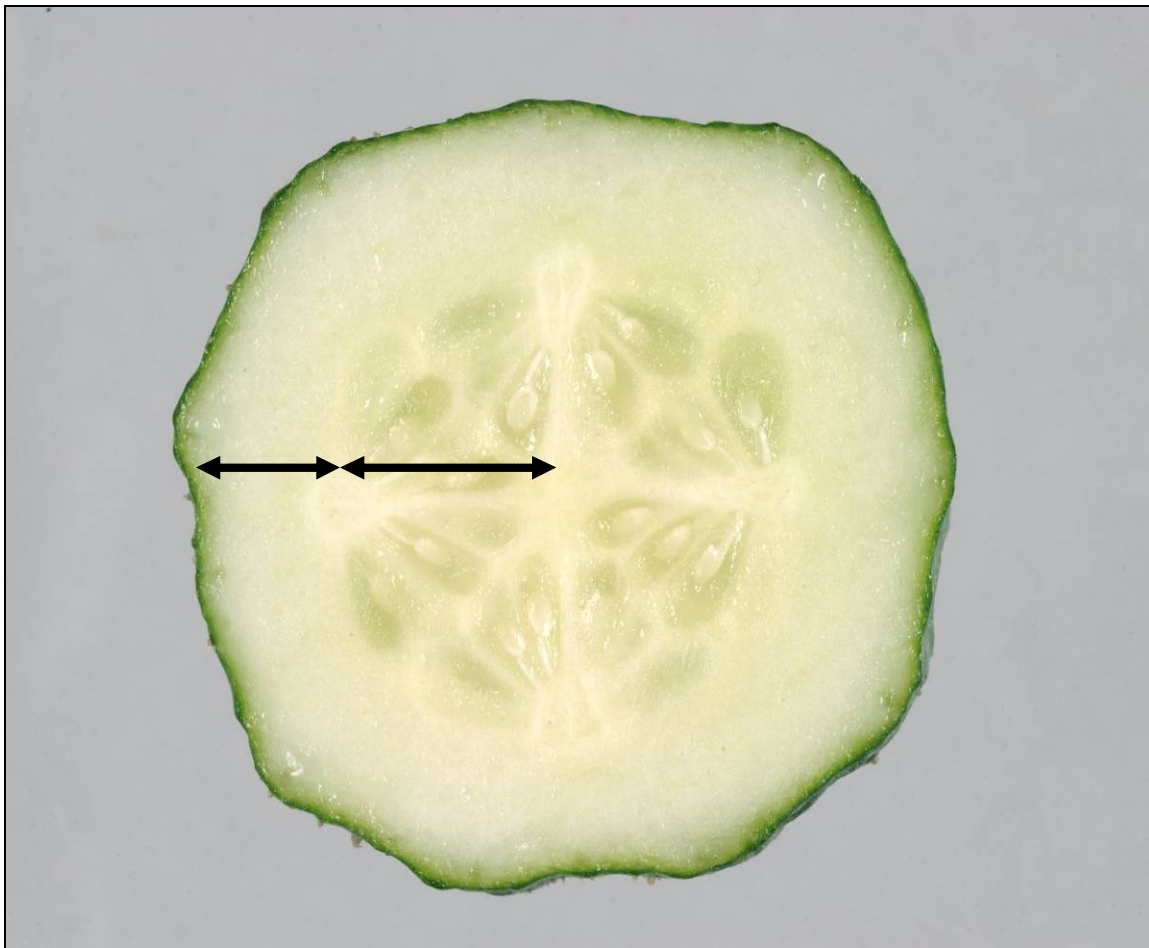

6: medium to large

21 Fruit: shape in transverse section

Grouping characteristic: no.

Type of characteristic: **QN** – Quantitative characteristic.

Type of observation: **VG** – Single visual assessment of a group of plants or parts of plants; in practice a single assessment of an average single plant or part of plant

Stage of observation: on stem fruits around 14 days after the flower has blossomed, between the 5th and 15th node

Method of observation: Visual observation. Calibrate using the explanatory drawings.

Notes and states of expression:

- 1: round
- 2: round to angular
- 3: angular

CPVO explanation:

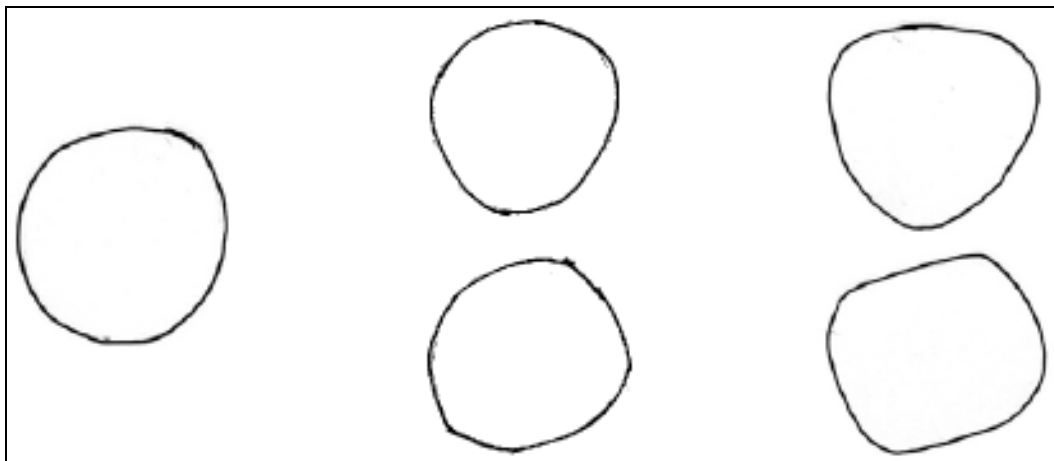

1: round

2: round to angular

3: angular

22 Fruit: shape of stem end

Grouping characteristic: no.

Type of characteristic: **QN** – Quantitative characteristic.

Type of observation: **VG** – Single visual assessment of a group of plants or parts of plants; in practice a single assessment of an average single plant or part of plant

Stage of observation: on stem fruits around 14 days after the flower has blossomed, between the 5th and 15th node

Method of observation: Visual observation. Calibrate using example varieties and explanatory photo's and drawings.

Notes, states of expression and example varieties:

- | | |
|-----------|---------------------|
| 1: necked | Sandra, Tasty Green |
| 2: acute | De Massy |
| 3: obtuse | Maram, Score |



3: Obtuse

2: Acute

1: Necked

CPVO explanation:

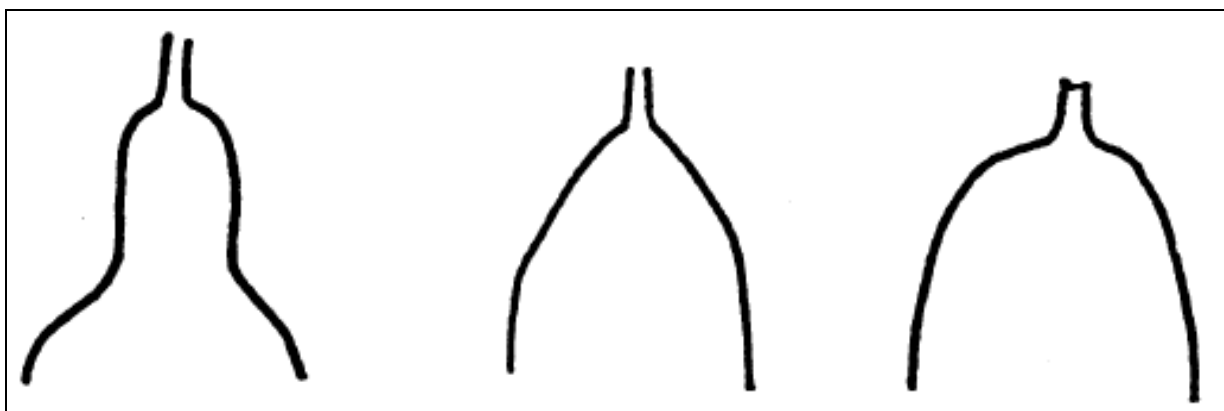

1: necked

2: acute

3: obtuse

23 Only necked varieties: Fruit: length of neck

Grouping characteristic: no.

Type of characteristic: **QN** – Quantitative characteristic.

Type of observation: **VG** – Single visual assessment of a group of plants or parts of plants; in practice a single assessment of an average single plant or part of plant.

Stage of observation: on stem fruits around 14 days after the flower has blossomed, between the 5th and 15th node

Method of observation: Visual observation. This characteristic can only be observed in with acute and necked stem end. (see previous character 22). In varieties with an obtuse stem end, no neck is present. Calibrate using example varieties and explanatory photo's and drawings.

Notes and states of expression:

- 1: very short
- 2: very short to short
- 3: short
- 4: short to medium
- 5: medium
- 6: medium to long
- 7: long
- 8: long to very long
- 9: very long

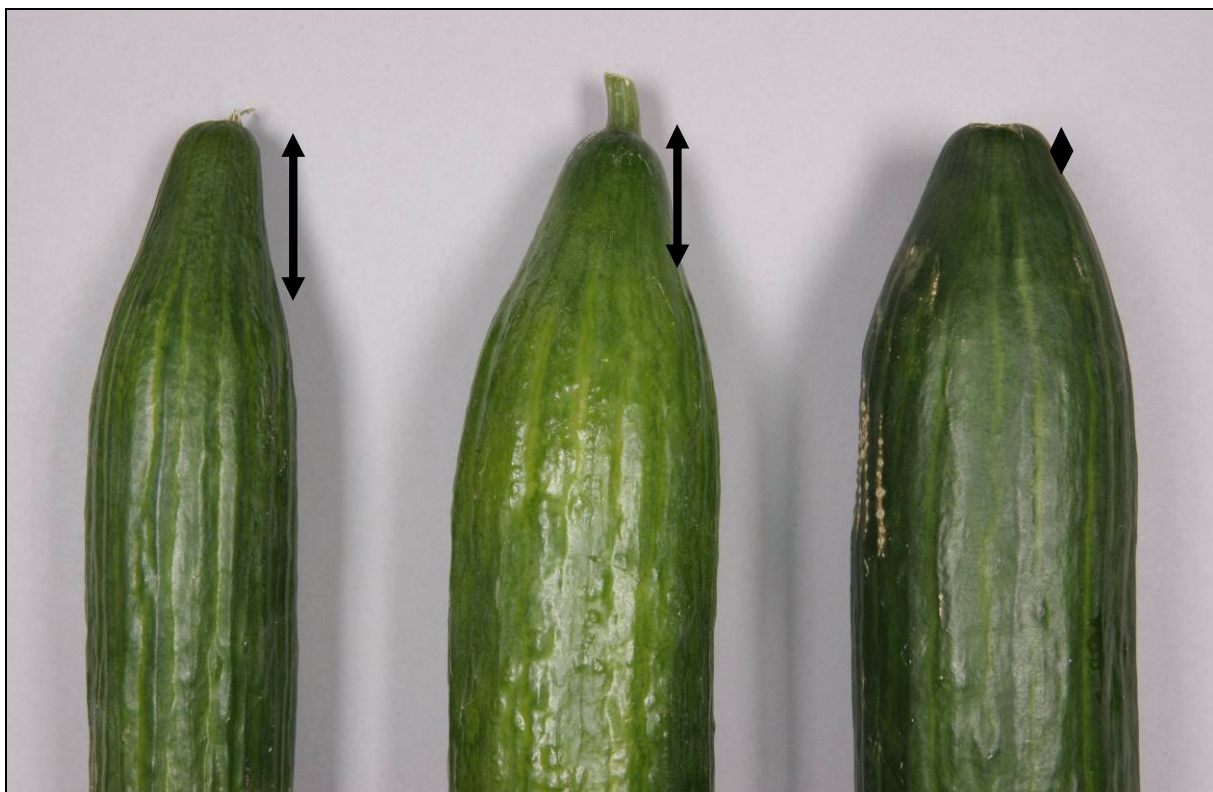

This photo serves only to illustrate some of the variation in expression present in the crop and should not be used as an absolute reference.

24 Fruit: shape of calyx end

Grouping characteristic: no.

Type of characteristic: PQ – Pseudo-qualitative characteristic.

Type of observation: VG – Single visual assessment of a group of plants or parts of plants; in practice a single assessment of an average single plant or part of plant.

Stage of observation: on stem fruits around 14 days after the flower has blossomed, between the 5th and 15th node

Method of observation: Visual observation. Calibrate using example varieties and explanatory photo's and drawings.

Notes and states of expression:

- 1: acute
- 2: obtuse
- 3: rounded
- 4: truncate

CPVO explanation:

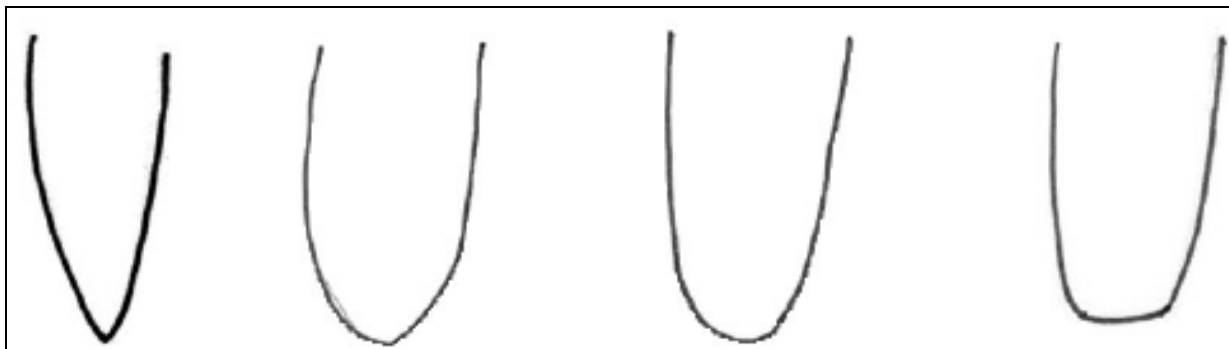

1: acute

2: obtuse

3: rounded

4: truncate



1: acute



2: obtuse



3: rounded



4: truncate

25 Fruit: ground colour of skin at market stage

Grouping characteristic: yes.

Type of characteristic: PQ – Pseudo-qualitative characteristic.

Type of observation: VG – Single visual assessment of a group of plants or parts of plants; in practice a single assessment of an average single plant or part of plant.

Stage of observation: on stem fruits around 14 days after the flower has blossomed, between the 5th and 15th node

Method of observation: Visual observation. Calibrate using example varieties and explanatory photo's.

Notes, states of expression and example varieties:

- | | |
|-----------|-----------|
| 1: white | Bonneuil |
| 2: yellow | Gele Tros |
| 3: green | Corona |



1: white

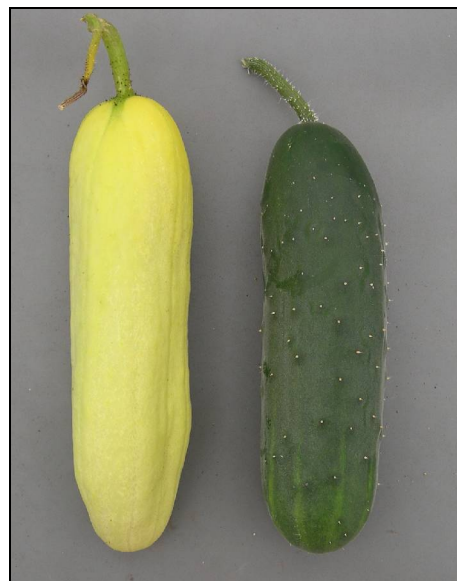

2: yellow

3: green

26 Excluding white varieties: Fruit: intensity of ground colour of skin

Grouping characteristic: no.

Type of characteristic: **QN** – Quantitative characteristic.

Type of observation: **VG** – Single visual assessment of a group of plants or parts of plants; in practice a single assessment of an average single plant or part of plant.

Stage of observation: on stem fruits around 14 days after the flower has blossomed, between the 5th and 15th node

Method of observation: Visual observation. Calibrate using example varieties.

Notes and states of expression:

- 1: very light
- 2: very light to light
- 3: light
- 4: light to medium
- 5: medium
- 6: medium to dark
- 7: dark
- 8: dark to very dark
- 9: very dark

27 Fruit: ribs

Grouping characteristic: no.

Type of characteristic: QN – Quantitative characteristic.

Type of observation: VG – Single visual assessment of a group of plants or parts of plants; in practice a single assessment of an average single plant or part of plant.

Stage of observation: on stem fruits around 14 days after the flower has blossomed, between the 5th and 15th node

Method of observation: Visual observation. The ribs follow the carpels of the fruit from the stem end to the blossom end. Calibrate using example varieties and expository drawing
The assessment of the character can be aided by touching the outside surface of the fruit.

Notes and states of expression:

- 1: absent or weak
- 2: medium
- 3: strong

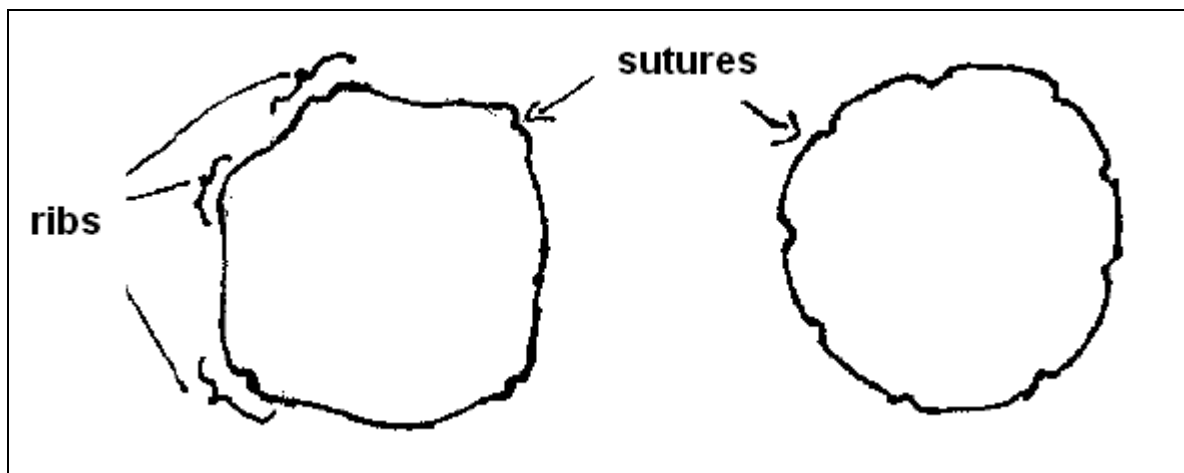

Ribs

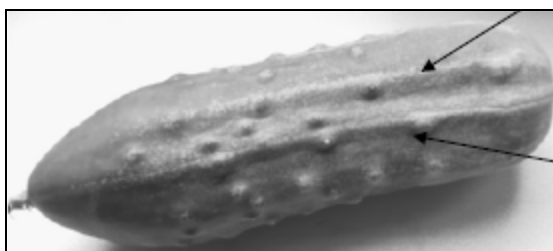

28 Fruit: sutures

Grouping characteristic: no.

Type of characteristic: QL – Qualitative characteristic.

Type of observation: VG – Single visual assessment of a group of plants or parts of plants; in practice a single assessment of an average single plant or part of plant.

Stage of observation: on stem fruits around 14 days after the flower has blossomed, between the 5th and 15th node

Method of observation: Visual observation. The sutures are the depressions to be observed on the surface of the fruit following the border between the carpels. Calibrate using example varieties and explanatory photo and drawings.

Notes and states of expression:

- 1: absent
- 2: present

CPVO explanation:

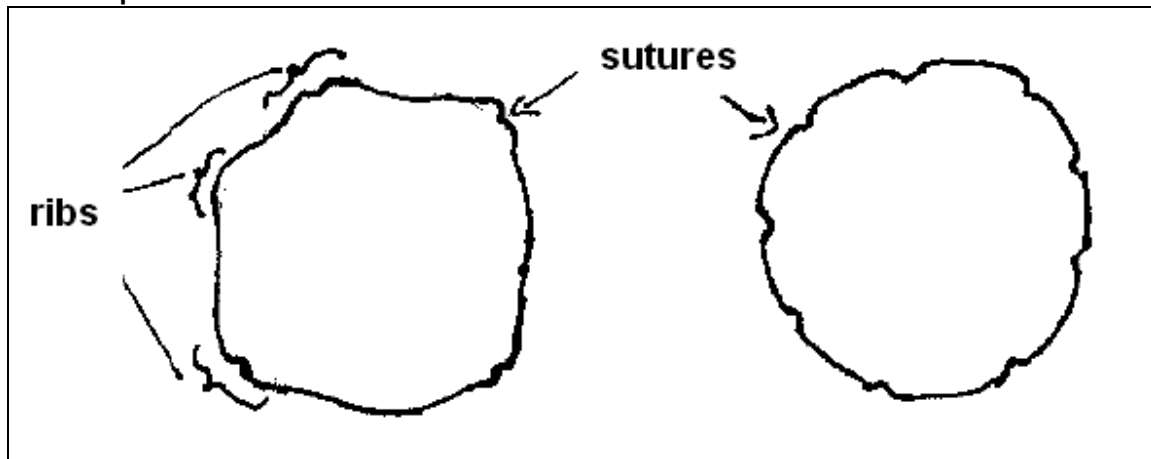

Sutures are slightly depressed in relation to the fruit surface.

29 Fruit: creasing

Grouping characteristic: no.

Type of characteristic: QL – Qualitative characteristic.

Type of observation: VG – Single visual assessment of a group of plants or parts of plants; in practice a single assessment of an average single plant or part of plant.

Stage of observation: on stem fruits around 14 days after the flower has blossomed, between the 5th and 15th node

Method of observation: Visual observation. The creasing is the undulation of the surface of the fruit independently of the position of the carpels. Calibrate using example varieties and explanatory drawing and photo.

Notes and states of expression:

- 1: absent
- 2: present

CPVO explanation:

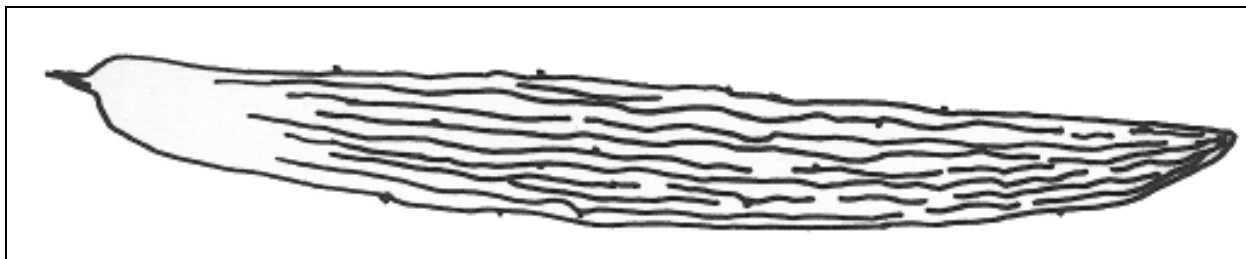

1: absent

9: present

30 Fruit: degree of creasing

Grouping characteristic: no.

Type of characteristic: QN – Quantitative characteristic.

Type of observation: VG – Single visual assessment of a group of plants or parts of plants; in practice a single assessment of an average single plant or part of plant.

Stage of observation: on stem fruits around 14 days after the flower has blossomed, between the 5th and 15th node

Method of observation: Visual observation. The creasing is the undulation of the surface of the fruit independently of the position of the carpels. Calibrate using example varieties and explanatory drawing and photo. (see 29)

Notes and states of expression:

- 1: very weak
- 2: very weak to weak
- 3: weak
- 4: weak to medium
- 5: medium
- 6: medium to strong
- 7: strong
- 8: strong to very strong
- 9: very strong



1: very weak



4: weak to medium



5: medium



7: strong

31 Fruit: type of vestiture

Grouping characteristic: no.

Type of characteristic: QL – Qualitative characteristic.

Type of observation: VG – Single visual assessment of a group of plants or parts of plants; in practice a single assessment of an average single plant or part of plant.

Stage of observation: on stem fruits around 14 days after the flower has blossomed, between the 5th and 15th node

Method of observation: Visual observation. Hairs are cell structures of one cell thick. Prickles are conical structures of many cells... Calibrate using example varieties and explanatory drawings and photo.

Notes, states of expression and example varieties:

- | | |
|-----------------------|------------------------|
| 1: hairs only | Silor |
| 2: hairs and prickles | De Bourbonne, De Massy |
| 3: prickles only | Corona, Jazzer |

CPVO explanation:

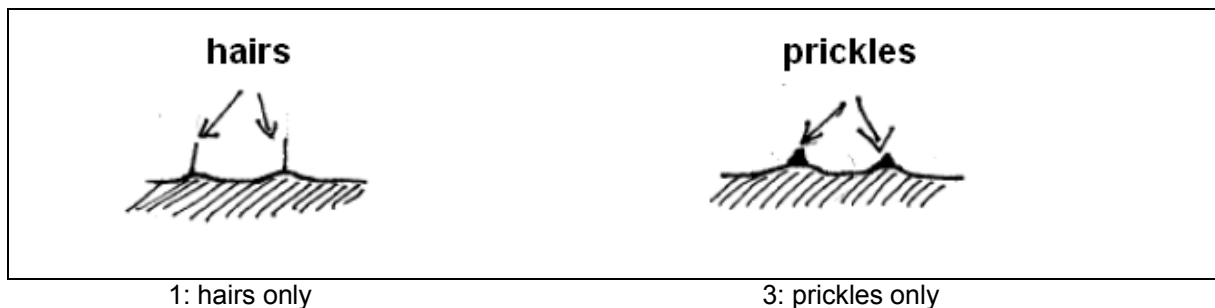

31 Fruit: type of vestiture

Hairs and prickles on fruits at young stage



1: hairs only

3: prickles only

32 Fruit: density of vestiture

Grouping characteristic: no.

Type of characteristic: QN – Quantitative characteristic.

Type of observation: VG – Single visual assessment of a group of plants or parts of plants; in practice a single assessment of an average single plant or part of plant.

Stage of observation: on stem fruits around 14 days after the flower has blossomed, between the 5th and 15th node .

Method of observation: Visual observation. Calibrate using example varieties. (see also character 31).

Notes and states of expression:

- 1: very sparse
- 2: very sparse to sparse
- 3: sparse
- 4: sparse to medium
- 5: medium
- 6: medium to dense
- 7: dense
- 8: dense to very dense
- 9: very dense

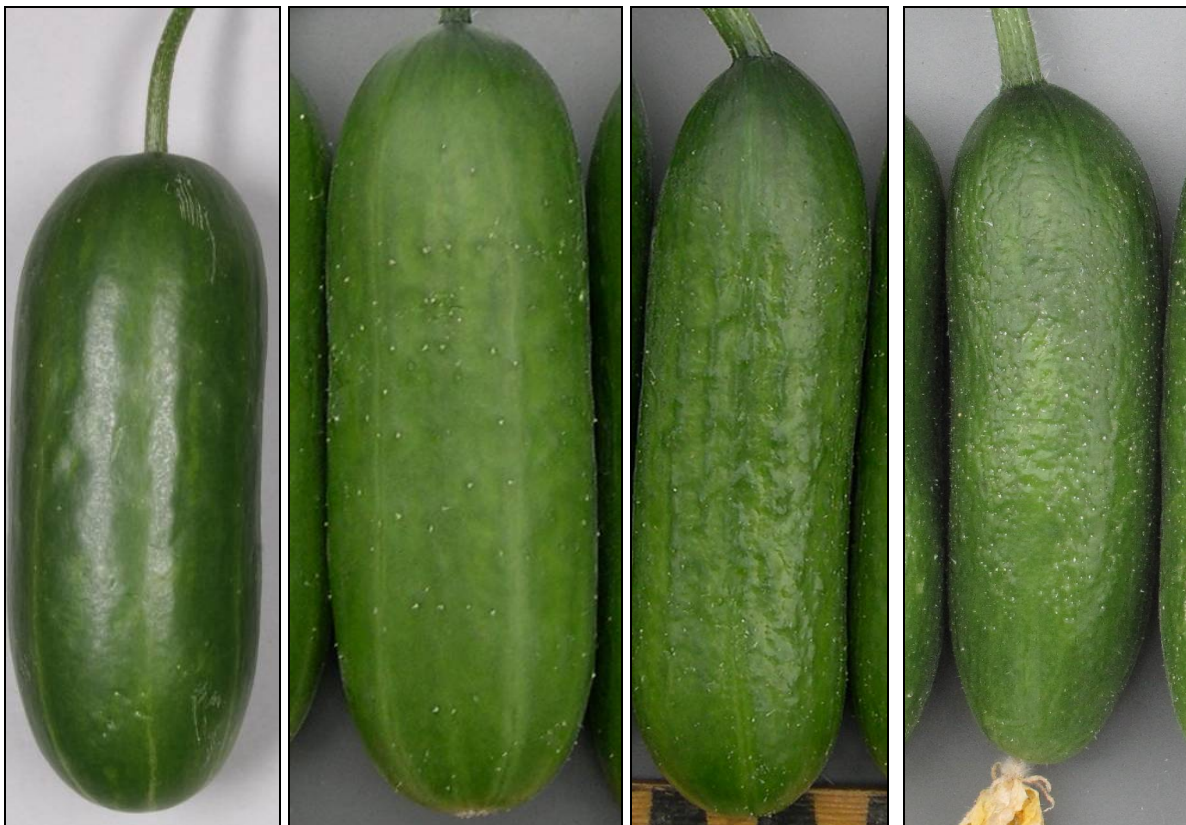

1: very sparse

3: sparse (spined)

5: medium (hairy)

7: strong (hairy)

33 Only varieties with white ovary vestiture; Fruit: colour of vestiture

Grouping characteristic: no.

Type of characteristic: **PQ** – Pseudo-qualitative characteristic.

Type of observation: **VG** – Single visual assessment of a group of plants or parts of plants; in practice a single assessment of an average single plant or part of plant.

Stage of observation: on stem fruits around 14 days after the flower has blossomed, between the 5th and 15th node

Method of observation: Visual observation. Calibrate using example varieties.

Notes and states of expression:

- 1: white
- 2: light brown
- 3: dark brown

34 Fruit: warts

Grouping characteristic: no.

Type of characteristic: QL – Qualitative characteristic.

Type of observation: VG – Single visual assessment of a group of plants or parts of plants; in practice a single assessment of an average single plant or part of plant.

Stage of observation: on stem fruits around 14 days after the flower has blossomed, between the 5th and 15th node

Method of observation: Visual observation. Calibrate using example varieties and explanatory photo.

Notes and states of expression:

1: absent

2: present

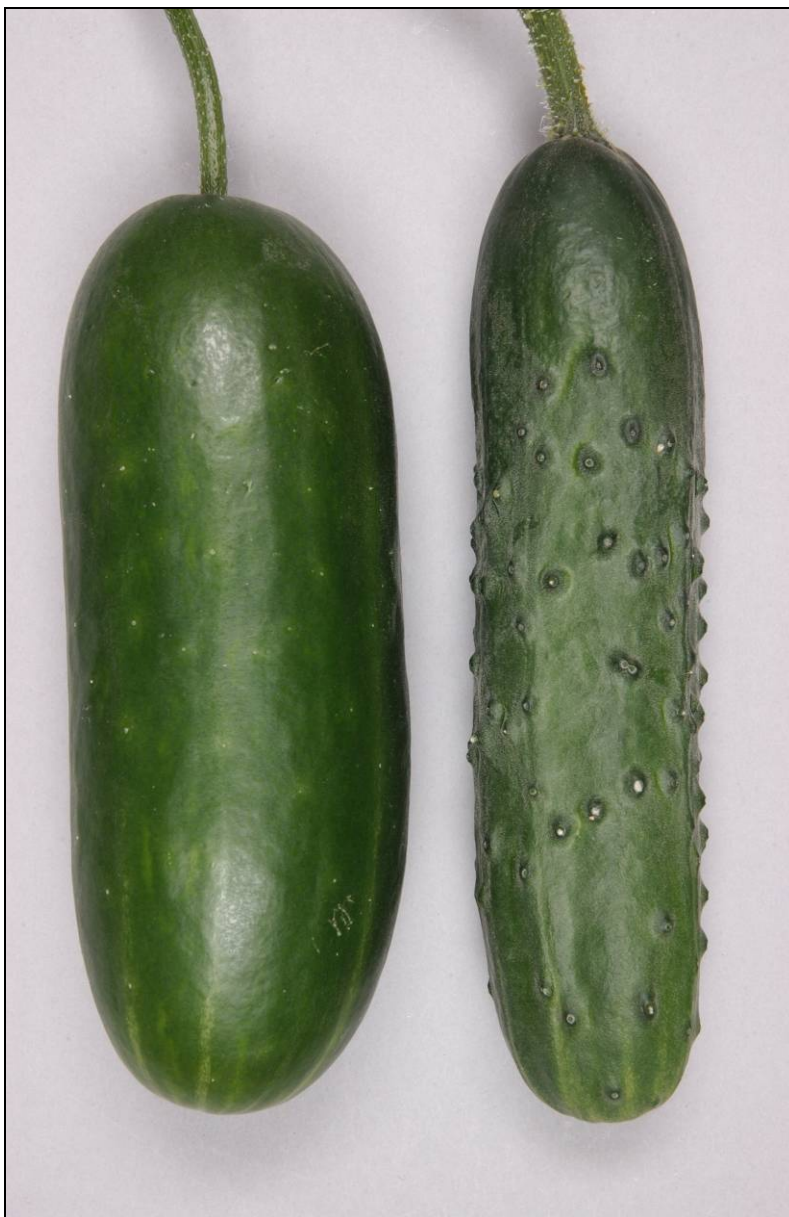

1: absent

9: present

35 Fruit: size of warts

Grouping characteristic: no.

Type of characteristic: **QN** – Quantitative characteristic.

Type of observation: **VG** – Single visual assessment of a group of plants or parts of plants; in practice a single assessment of an average single plant or part of plant.

Stage of observation: on stem fruits around 14 days after the flower has blossomed, between the 5th and 15th node

Method of observation: Visual observation. Calibrate using example varieties.

Notes and states of expression:

- 1: very small
- 2: very small to small
- 3: small
- 4: small to medium
- 5: medium
- 6: medium to large
- 7: large
- 8: large to very large
- 9: very large

36 Fruit: length of stripes

Grouping characteristic: no.

Type of characteristic: QN – Quantitative characteristic.

Type of observation: VG – Single visual assessment of a group of plants or parts of plants; in practice a single assessment of an average single plant or part of plant.

Stage of observation: on stem fruits around 14 days after the flower has blossomed, between the 5th and 15th node

Method of observation: Visual observation. This characteristic can only be observed in varieties that have stripes. When fruits have stripes that end in the middle section a 5 (medium) is selected. Stripes are characterized by color and not by a depression of the fruit surface. Calibrate using example varieties and explanatory photo.

Notes and states of expression:

- 1: absent or very short
- 2: very short to short
- 3: short
- 4: short to medium
- 5: medium
- 6: medium to long
- 7: long
- 8: long to very long
- 9: very long



1: very short

3: short

5: medium

7: long

9: very long

37 Fruit: dots

Grouping characteristic: no.

Type of characteristic: QL – Qualitative characteristic.

Type of observation: VG – Single visual assessment of a group of plants or parts of plants; in practice a single assessment of an average single plant or part of plant.

Stage of observation: on stem fruits around 14 days after the flower has blossomed, between the 5th and 15th node

Method of observation: Visual observation. Calibrate using example varieties.

Notes and states of expression:

1: absent

2: present



1: absent



9: present

38 Fruit: distribution of dots

Grouping characteristic: no.

Type of characteristic: PQ – Pseudo-qualitative characteristic.

Type of observation: VG – Single visual assessment of a group of plants or parts of plants; in practice a single assessment of an average single plant or part of plant.

Stage of observation: on stem fruits around 14 days after the flower has blossomed, between the 5th and 15th node. The density of dots should be observed in the areas with dots present and not on the fruit as a whole.

Method of observation: Visual observation. Calibrate using example varieties and explanatory photo's.

Notes and states of expression:

- 1: in bands only
- 2: predominantly in bands
- 3: evenly distributed

CPVO explanation:



1. in bands only



2. predominantly in bands



3. evenly distributed

39 Fruit: length of fruit containing dots

Grouping characteristic: no.

Type of characteristic: **PQ** – Pseudo-qualitative characteristic.

Type of observation: **VG** – Single visual assessment of a group of plants or parts of plants; in practice a single assessment of an average single plant or part of plant.

Stage of observation: on stem fruits around 14 days after the flower has blossomed, between the 5th and 15th node

Method of observation: Visual observation. Calibrate using example varieties.

Notes and states of expression:

- 1: distal 1/3
- 2: distal 1/2
- 3: distal 2/3
- 4: excluding area around peduncle
- 5: whole length

40 Fruit: density of dots

Grouping characteristic: no.

Type of characteristic: **QN** – Quantitative characteristic.

Type of observation: **VG** – Single visual assessment of a group of plants or parts of plants; in practice a single assessment of an average single plant or part of plant.

Stage of observation: on stem fruits around 14 days after the flower has blossomed, between the 5th and 15th node

Method of observation: Visual observation. Calibrate using example varieties.

Notes and states of expression:

1: very sparse

2: very sparse to sparse

3: sparse

4: sparse to medium

5: medium

6: medium to dense

7: dense

8: dense to very dense

9: very dense

41 Fruit: glaucosity

Grouping characteristic: no.

Type of characteristic: QN – Quantitative characteristic.

Type of observation: VG – Single visual assessment of a group of plants or parts of plants; in practice a single assessment of an average single plant or part of plant.

Stage of observation: on stem fruits around 14 days after the flower has blossomed, between the 5th and 15th node

Method of observation: Visual observation. Glaucosity is a whitish or grayish waxy layer which can be removed by rubbing. Observe and compare with example varieties. Calibrate using example varieties.

Notes and states of expression:

- 1: absent or very weak
- 2: very weak to weak
- 3: weak
- 4: weak to medium
- 5: medium
- 6: medium to strong
- 7: strong
- 8: strong to very strong
- 9: very strong



1: absent or very weak



3: weak



5: medium

42 Fruit: length of peduncle

Grouping characteristic: no.

Type of characteristic: QN – Quantitative characteristic.

Type of observation: MS/VG – Choice between

- Calculated average of the measurement of 20 plants or parts of plants and
- Single visual assessment of a group of plants or parts of plants; in practice a single assessment of an average single plant or part of plant

Stage of observation: on stem fruits around 14 days after the flower has blossomed, between the 5th and 15th node

Method of observation: Calibrate using example varieties.

Notes and states of expression:

- 1: very short
- 2: very short to short
- 3: short
- 4: short to medium
- 5: medium
- 6: medium to long
- 7: long
- 8: long to very long
- 9: very long



This image serves only to illustrate some variation in expression present in the crop and should not be used as an absolute reference.

43 Fruit: ground colour of skin at physiological ripeness

Grouping characteristic: no.

Type of characteristic: PQ – Pseudo-qualitative characteristic.

Type of observation: VG – Single visual assessment of a group of plants or parts of plants; in practice a single assessment of an average single plant or part of plant.

Stage of observation: Perform all observations after the harvesting stage on fully developed harvested fruits. The fruit is at physiological ripeness when it is fully developed and mature and there are no further changes to the colour of the skin, before the fruit starts to rot.

Method of observation: Visual observation. Keep several fruits of each variety separately to the moment they have changed colour. Calibrate using example varieties.

Notes and states of expression:

- 1: white
- 2: yellow
- 3: green
- 4: orange
- 5: brown



2: yellow



4: orange

44 Resistance to *Cladosporium cucumerinum* (Ccu)

Grouping characteristic: yes.

Type of characteristic: QL – Qualitative characteristic.

Type of observation: VSVG: - Choice between

- Calculated average of the individual visual assessments of 20 plants or parts of plants and
- Single visual assessment of a group of plants or parts of plants; in practice a single assessment of an average single plant or part of plant

Method of observation: Visual assessment using explanation.

Notes, states of expression and example varieties:

- 1: absent Pepinex 69
- 2: present Marketmore 76

44 Resistance to *Cladosporium cucumerinum* (Ccu)

CPVO explanation:

Resistance to *Cladosporium cucumerinum*

Method

Maintenance of disease

Type of medium:	PDA (Potato Dextrose Agar)
Special conditions:	7-8 days in the dark at 20°C
Remarks:	The spore suspension should have a concentration of 0.5×10^5 spores/ml. Keep maximum 4 days in refrigerator at 4°C.
<u>Preparation of inoculum:</u>	Scrape off the fungus from the DPA medium, collect it in a beaker and filter it through a cheese cloth.

Raising the plants

Sowing:	In potting soil or compost
Temperature:	22/20°C (day/night)
Light:	At least 16 hours
Number of plants:	30 plants per sample

Inoculation

Growth stage of plants:	The plants should have a first leaf with a diameter of 3 centimeters.
Method of inoculation:	Spraying of spore suspension on leaves

Special conditions after inoculation

Temperature:	22/20°C (day/night)
Light:	At least 16 hours
Special conditions:	Plastic cover placed over the plants. The plastic cover is closed during the first three days and thereafter slightly opened during the daytime.

Duration of test

- From sowing to inoculation:	12 days
- From inoculation to last reading:	6-8 days

Standard varieties:

Resistance absent :	Pepinex 69
Resistance present:	Marketmore 76

45 Resistance to Cucumber Mosaic Virus (CMV)

Grouping characteristic: yes.

Type of characteristic: **QN** – Quantitative characteristic.

Type of observation: **VS/VG:** - Choice between

- Calculated average of the individual visual assessments of 20 plants or parts of plants and
- Single visual assessment of a group of plants or parts of plants; in practice a single assessment of an average single plant or part of plant

Method of observation: Visual assessment using explanation.

Notes, states of expression and example varieties:

- | | |
|-------------------------|-----------|
| 1: susceptible | Gele Tros |
| 2: moderately resistant | Flamingo |
| 3: highly resistant | Cordoba |

45 Resistance to Cucumber Mosaic Virus (CMV)

CPVO explanation:

Resistance to Cucumis Mosaic Virus (CMV)

Method

Maintenance of disease

Type of medium:

On susceptible living plants

Remarks:

Greenhouse to be kept free from aphids

Preparation of inoculum:

Mix freshly infected leaves with water. Prepare a solution with a concentration of 1:15 (inoculum: water).

Raising the plants

Sowing:

In potting soil or compost

Temperature:

22/20°C (day/night)

Light:

At least 16 hours

Number of plants:

30 plants per sample

Inoculation

Growth stage of plants:

Fully developed cotyledons

Method of inoculation:

Mechanical inoculation, by rubbing the cotyledons
Using carborundum powder. Carborundum powder to be washed away after inoculation.

Special conditions after inoculation

Temperature:

22/18°C (day/night)

Light:

at least 16 hours

Duration of test

- From sowing to inoculation:

6-7 days

- From inoculation to last reading:

10-14 days

Scheme of observation:

1 Susceptible:

II

restricted growth, cotyledon slightly blistered, leaves completely mottled

Gele Tros

III

curled leaves, heavy mosaic symptoms over whole Leaf

2 Moderately resistant

IV

curled leaves, slight mosaic symptoms

Gardon

V

slightly curled leaves, slight mosaic symptoms, many necrotic spots

VI

leaves not curled, vague mosaic symptoms, few necrotic spots

3 Highly resistant

VII

very few virus symptoms, very few necrotic spots

VIII

no symptoms

Hokus, Naf

46 Resistance to powdery mildew (*Podospaera xanthii*) (Px)

Grouping characteristic: yes.

Type of characteristic: QN – Quantitative characteristic.

Type of observation: VS/VG: - Choice between

- Calculated average of the individual visual assessments of 20 plants or parts of plants and
- Single visual assessment of a group of plants or parts of plants; in practice a single assessment of an average single plant or part of plant

Method of observation: Visual assessment using explanation.

Notes, states of expression and example varieties:

- | | |
|-------------------------|----------|
| 1: susceptible | Corona |
| 2: moderately resistant | Flamingo |
| 3: highly resistant | Cordoba |

46 Resistance to powdery mildew (*Pododospaera xanthii*) (Px)

CPVO explanation:

Method

Maintenance of disease

Type of medium: On susceptible living plants

Preparation of inoculum:

Wash the spores from the infected leaves and prepare a suspension with a concentration of 10^5 spores/ml. Filter the suspension through a cheese-cloth before infecting the plants.

Raising the plants

Sowing: In potting soil or compost

Temperature: 22/20°C (day/night)

Light: At least 16 hours

Number of plants: 30 plants per sample

Inoculation

Growth stage of plants: Fully developed cotyledons

Method of inoculation: Spraying of spore suspension on leaves on the first, the second and the fifth day after planting out.

Special conditions after inoculation

Temperature: 20/20°C (day/night)

Light: 16 hours

Duration of test

- From sowing to inoculation: 7, 8 and 11 days

- From inoculation to last reading: 12 days

Scheme of observations:

1. Susceptible: hypocotyls and cotyledons infected, first leaf strongly infected, high sporulation.
2. Moderately resistant: hypocotyls not infected, cotyledons and first leaf moderately infected with moderate sporulation, moderate colonization.
3. Highly resistant: hypocotyls and cotyledons not infected, first leaf very weakly or not infected, few colonies, very weak sporulation.

Standard varieties:

1. Susceptible: Corona
2. Moderately resistance: Flamingo
3. Highly resistant: Cordoba

47 Resistance to downy mildew (*Pseudoperonospora cubensis*) (Pc)

Grouping characteristic: yes.

Type of characteristic: **QN** – Quantitative characteristic.

Type of observation: VS/VG: - Choice between

- Calculated average of the individual visual assessments of 20 plants or parts of plants and
- Single visual assessment of a group of plants or parts of plants; in practice a single assessment of an average single plant or part of plant

Method of observation: Visual assessment using explanation.

Notes, states of expression and example varieties:

- 1: susceptible
- 2: moderately resistant
- 3: highly resistant

47 Resistance to downy mildew (*Pseudoperonospora cubensis*) (Pc)

CPVO explanation:

Method

Maintenance of races

Type of medium:

On susceptible living plants

Preparation of inoculum:

Wash the spores from the infected leaves with cold distilled water and prepare a suspension. Suspension to be used immediately.

Raising the plants

Sowing:

In potting soil or compost

Temperature:

22/20°C (day/night)

Light:

At least 16 hours

Number of plants:

30 plants per sample

Inoculation

Growth stage of plants:

First two leaves fully developed

Method of inoculation:

Spray spore suspension on leaves.

Special conditions after inoculation

Temperature:

22/20°C (day/night)

Light:

16 hours

Relative humidity:

100%, 48 hours after inoculation

Special conditions:

Plastic cover placed over the plants. The plastic cover is closed during the first three days and thereafter then slightly opened during daytime.

Duration of test

- From sowing to inoculation:

20 days

- From inoculation to last reading:

± 10 days

Scheme of observations:

1. Susceptible:

Large lesions with abundant spore production, leaf tissue becoming necrotic within 5 days.

2. Moderately resistant:

Medium lesions, period of tissue yellowing prolonged to beyond 10 days.

3. Highly resistant:

Small downy mildew lesions, round tissue in the centre becoming necrotic, no visual spore production.

Standard varieties:

1. Susceptible :

Pepinex 69

2. Moderately resistant:

Poinsett

3. Highly resistant

48 Resistance to *Corynespora* blight and target leaf spot (*Corynespora cassiicola*) (Cca)

Grouping characteristic: yes.

Type of characteristic: QL – Qualitative characteristic.

Type of observation: VS/VG: - Choice between

- Calculated average of the individual visual assessments of 20 plants or parts of plants and
- Single visual assessment of a group of plants or parts of plants; in practice a single assessment of an average single plant or part of plant

Method of observation: Observe using explanation.

Notes, states of expression and example varieties:

- | | |
|------------|--------------------------|
| 1: absent | Cerrucho, Goya, Pepinova |
| 2: present | Corona, Cumlaude, Edona |

48 Resistance to *Corynespora* blight and target leaf spot (*Corynespora cassiicola*) (Cca)

CPVO explanation:

Method

Maintenance of disease

Type of medium:	PDA (Potato Dextrose Agar)
Special conditions:	12-14 days in the dark at 20°C
Remarks:	The spore suspension should have a concentration of 0.5×10^5 spores/ml. Keep maximum 4 days in refrigerator at 4°C.

<u>Preparation of inoculum:</u>	Scrape off the fungus from the DPA medium, collect it in a beaker and filter it through a cheese cloth.
---------------------------------	---

Raising the plants

Sowing:	In potting soil or compost
Temperature:	22/20°C (day/night)
Light:	At least 16 hours
Number of plants:	30 plants per sample

Inoculation

Growth stage of plants:	The plants should have a first leaf with a diameter of 3 centimeters.
Method of inoculation:	Spraying of spore suspension on leaves

Special conditions after inoculation

Temperature:	25/15°C (day/night)
Light:	At least 16 hours
Special conditions:	Plastic cover placed over the plants. The plastic cover is closed during the first three days and thereafter slightly opened during the daytime.

Duration of test

- From sowing to inoculation:	12-13 days
- From inoculation to last reading:	8-10 days

Scheme of observation:

1. Susceptible
 - a. Cotyledons and first leaf dead, plant with greatly reduced growth
 - b. Cotyledons dead or strongly infected, first leaf weakly infected, plant with greatly reduced growth
2. Resistant
 - a. Cotyledons heavily infected, first leaf not infected, plant with normal growth
 - b. Cotyledons and first not infected, plant with normal growth
- 3.

Standard varieties:

Resistance absent :	Pepinova (1a0 and Cerrucho, Goya (1b)
Resistance present:	Cumlaude, Edona (2a) and Corona (2b)

49 Resistance to Cucumber Vein Yellowing Virus (CVYV)

Grouping characteristic: yes.

Type of characteristic: QL – Qualitative characteristic.

Type of observation: VS/VG: - Choice between

- Calculated average of the individual visual assessments of 20 plants or parts of plants and
- Single visual assessment of a group of plants or parts of plants; in practice a single assessment of an average single plant or part of plant

Method of observation: Visual assessment using explanation.

Notes, states of expression and example varieties:

- 1: absent Corona
- 2: present Tornac

CPVO explanation:

Method

Maintenance of isolate

Type of medium: On susceptible living plants
Special conditions: Fresh inoculum, or inoculum which has been stored for a maximum of 3 months at - 20°C

Execution of test

Growth stage of plants: appearance of first leaf
Temperature: 16 to 30°C
Light: 16 hours
Growing method: greenhouse
Method of inoculation: mechanical, by rubbing of cotyledons
Duration of test: from inoculation to reading: 14 days
Number of plants tested: at least 20 plants

Standard varieties: susceptible: Corona
resistant: Tornac

Remark: resistant varieties may give a slight discoloration of the veins of older leaves. Susceptible varieties have systemic symptoms.

50 Resistance to Zucchini Yellow Mosaic Virus (ZYMV)

Grouping characteristic: no.

Type of characteristic: QL – Qualitative characteristic.

Type of observation: VS/VG: - Choice between

- Calculated average of the individual visual assessments of 20 plants or parts of plants and
- Single visual assessment of a group of plants or parts of plants; in practice a single assessment of an average single plant or part of plant

Method of observation: Visual assessment using explanation.

Notes, states of expression and example varieties:

- 1: absent Corona
- 2: present Dina

CPVO explanation

Method

Maintenance of isolate

Type of medium: On susceptible living plants
Special conditions: Fresh inoculum or inoculum which has been stored for a maximum of 6 months at - 20°C

Execution of test

Growth stage of plants: Appearance of first leaf
Temperature: 23 to 25°C day and night
Light: 16 hours
Growing method: Greenhouse
Method of inoculation: Mechanical, by rubbing of cotyledons
Duration of test: From inoculation to reading: 14 days
Number of plants tested: At least 20 plants

Standard varieties: Susceptible: Corona
Resistant: Dina

Remark: Resistant varieties may have a slight discoloration of the veins of older leaves.
Susceptible varieties give systemic mosaic symptoms.

Notes

Notes



nak  *tuinbouw*

Naktuinbouw, Variety Testing Department, Sotaweg 22, Postbus 40, 2370 AA Roelofarendsveen, The Netherlands

Tel. +31 (0)71 332 61 39 E-mail: kalibratieboek@naktuinbouw.nl Website: www.naktuinbouw.com